

$$V_{DS} = 1200V$$

$$R_{DSon} = 13m\Omega$$

$$I_D = 105A @ T_c = 25^\circ C$$

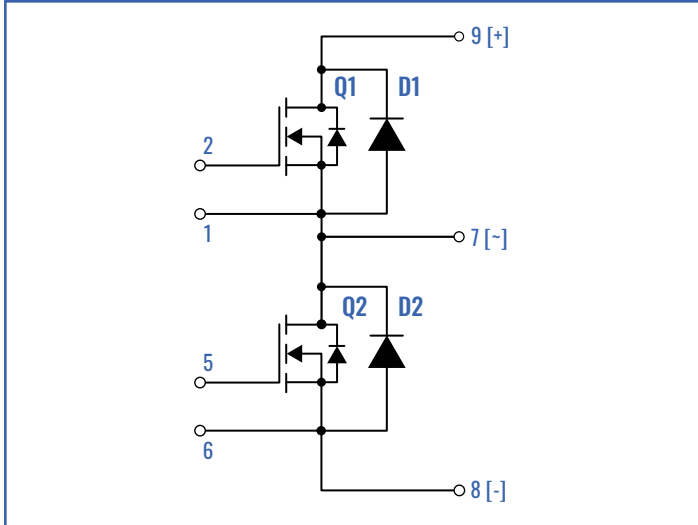

PIN CONNECTIONS

PIN	DESCRIPTION
1	S1
2	G1
3	n/c
4	n/c
5	G2
6	S2
7	AC
8	N
9	P

FEATURES & BENEFITS

- SUPERIOR SYSTEM EFFICIENCY DUE TO LOW SWITCHING AND CONDUCTIONS LOSSES OF SiC
- OUTSTANDING POWER CONVERSION EFFICIENCY AT HIGH FREQUENCY OPERATION
- HIGH SPEED SWITCHING W/ LOW CAPACITANCE
- REDUCED PARASITIC INDUCTANCE AND CAPACITANCE
- REAL KELVIN SOURCE CONNECTION FOR STABLE GATE DRIVE
- ISOLATED BACKSIDE FOR DIRECT MOUNT TO HEATSINK
- ALN SUBSTRATE AND CUMO BASEPLATE FOR THERMAL CONDUCTIVITY
- HIGH JUNCTION TEMPERATURE OPERATION
- LOW JUNCTION TO CASE THERMAL RESISTANCE
- REDUCED THERMAL REQUIREMENTS AND SYSTEM COST
- RUGGED MOUNTING DUE TO INTEGRATED MOUNTING BUSHINGS
- LOW PROFILE COMPACT PACKAGE



ABSOLUTE MAXIMUM RATINGS ($T_c = 25^\circ\text{C}$)

SYMBOL	CHARACTERISTIC	TEST CONDITIONS	VALUE	UNIT
$V_{DS,max}$	Drain-Source Voltage	$V_{GS} = 0V, I_D = 100\mu A$	1200	V
$V_{GS,max}$	Gate-Source Voltage (dynamic)	Absolute maximum values	-8/+19	V
$V_{GS,op}$	Gate-Source Voltage	Recommended operational values	-4/+15	V
I_D	Continuous Drain Current	$V_{GS} = 15V$	105	A
$I_{D,pulse}$	Pulsed Drain Current	Pulse Width t_p Limited by T_{jmax}	420	A
P_D	Maximum Power Dissipation		265	W
T_j, T_{STG}	Junction Temperature, Operating and Storage		-55 to +175	$^\circ\text{C}$

ELECTRICAL CHARACTERISTICS ($T_c = 25^\circ\text{C}$)

SYMBOL	CHARACTERISTIC	TEST CONDITIONS	MIN.	TYP.	MAX.	UNIT
$V_{(BR)DSS}$	Drain-Source Breakdown Voltage	$V_{GS} < 0V, I_D = 100\mu A$	1200			V
$V_{GS(th)}$	Gate Threshold Voltage	$V_{DS} = V_{GS}, I_{DS} = 26.5mA, T_a = -55^\circ\text{C}$		3.263		V
		$V_{DS} = V_{GS}, I_{DS} = 26.5mA, T_a = 25^\circ\text{C}$	1.8	2.5	3.6	
		$V_{DS} = V_{GS}, I_{DS} = 26.5mA, T_a = 175^\circ\text{C}$		2.0		
I_{DSS}	Off -State Drain Current	$V_{GS} = 0V, V_{DS} = 1200V$		1	40	μA
I_{GSS}	Gate-Source Leakage Current	$V_{GS} = +15V, V_{DS} = 0V$		10	250	nA
$R_{DS(on)}$	Drain-Source On-state Resistance	$V_{GS} = 15V, I_D = 100A, T_j = 25^\circ\text{C}$	9.0	13	17	m Ω
		$V_{GS} = 15V, I_D = 100A, T_j = 175^\circ\text{C}$		21		
g_{fs}	Transconductance	$V_{DS} = 20V, I_{DS} = 100A, T_a = 25^\circ\text{C}$		71		S
		$V_{DS} = 20V, I_{DS} = 100A, T_a = 175^\circ\text{C}$		72		
C_{iss}^*	Input Capacitance	$V_{GS} = 0V, V_{DS} = 1000V, f = 100kHz, V_{ac} = 25mV$		7560		pF
C_{oss}^*	Output Capacitance			284		pF
C_{rss}^*	Reverse Transfer Capacitance			18		pF

BODY DIODE RATINGS AND CHARACTERISTICS ($T_c = 25^\circ\text{C}$)

SYMBOL	CHARACTERISTIC	TEST CONDITIONS	MIN.	TYP.	MAX.	UNIT
V_{SD}	Diode Forward Voltage	$V_{GS} = 0V, I_{SD} = 40A, T_j = 25^\circ\text{C}$		2.4		V
		$V_{GS} = 0V, I_{SD} = 40A, T_j = 175^\circ\text{C}$		2.2		V
t_{rr}	Reverse Recovery Time			43		nS
Q_{rr}	Reverse Recovery Charge			1800		nC
I_{rrm}	Peak Reverse Recovery Current			65		A

SiC DIODE RATINGS AND CHARACTERISTICS ($T_a = 25^\circ\text{C}$)

SYMBOL	CHARACTERISTIC	TEST CONDITIONS	MIN.	TYP.	MAX.	UNIT
I_F	Continuous Forward Current	Limited by T_j			20	A
I_{FSM}	Surge No Repetitive Forward Current	PW < 8.3mS, Sinusoidal			82	A
V_R	Reverse Voltage	$I_R = 0.4mA$	1200			V
V_F	Diode Forward Voltage	$I_F = 20A, T_j = 25^\circ\text{C}$		1.4		V
		$I_F = 20A, T_j = 175^\circ\text{C}$		1.9		V
C	Total Capacitance	$V_R = 1V, f = 1MHz$		1060		pF
		$V_R = 800V, f = 1MHz$		85		pF
Q_C	Total Capacitive Charge	$V_R = 800V, di/dt = 500A/\mu S$		65		pF

TYPICAL PERFORMANCE

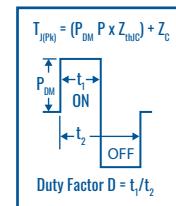
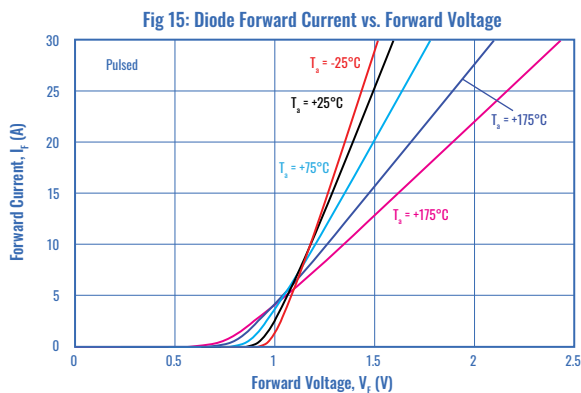
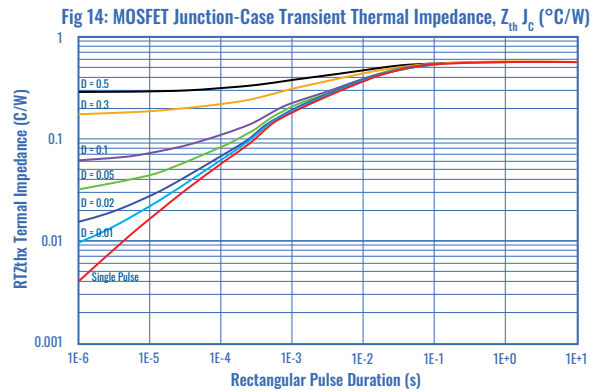
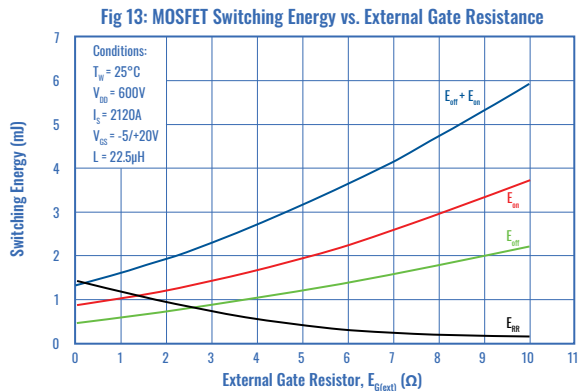
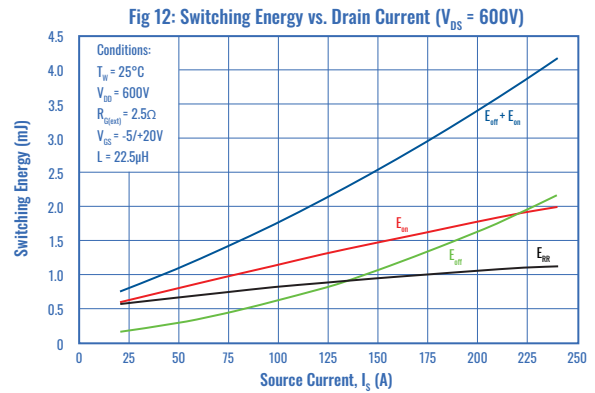
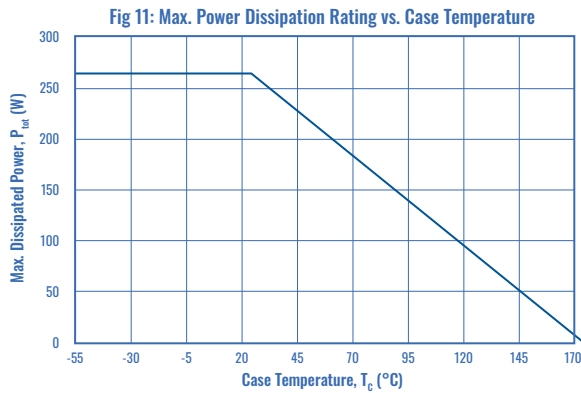
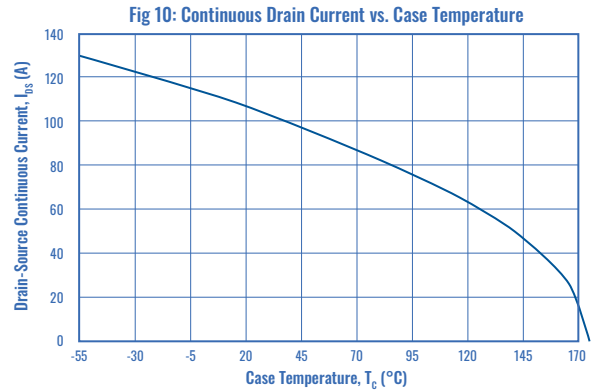
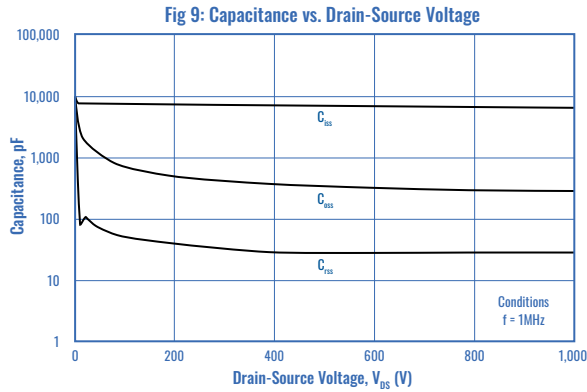

TYPICAL PERFORMANCE (cont.)

Fig 1: Output Characteristics $T_j = -55^\circ\text{C}$

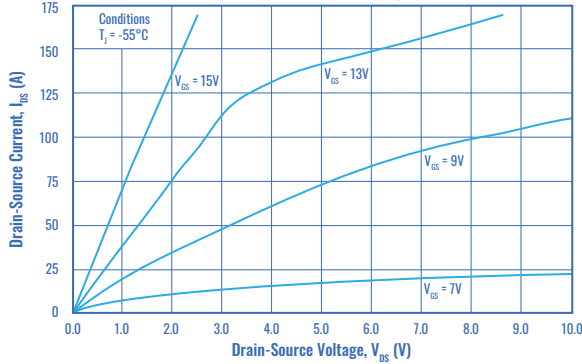

Fig 2: Output Characteristics $T_j = +25^\circ\text{C}$

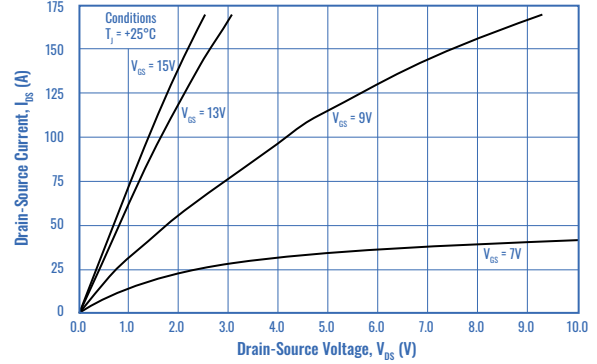

Fig 3: Output Characteristics $T_j = +175^\circ\text{C}$

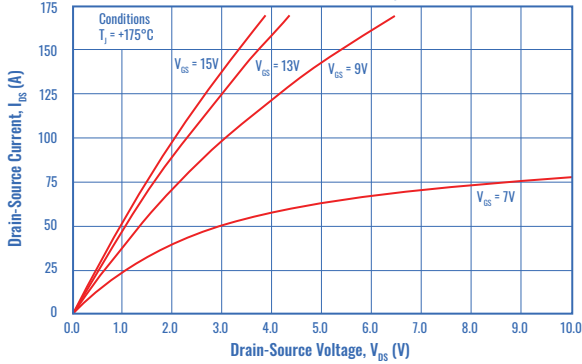

Fig 4: On-Resistance vs. Drain Current

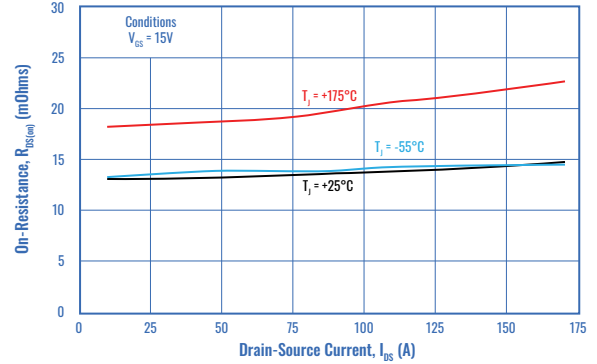

Fig 5: On-Resistance vs. Junction Temperature

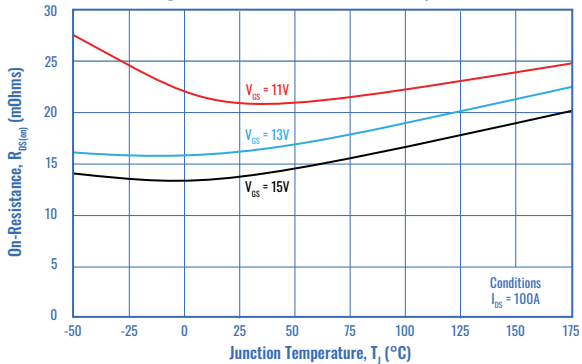

Fig 6: Transfer Characteristic

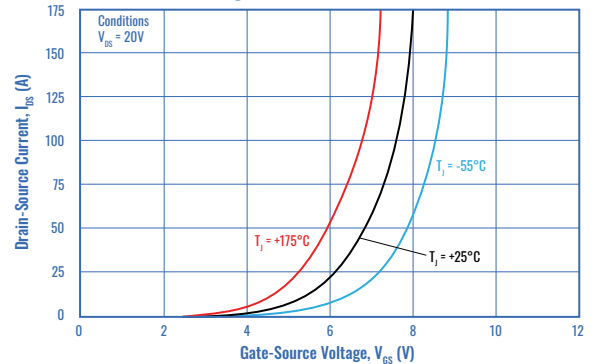

Fig 7: Body Diode Characteristic at Various Temperatures

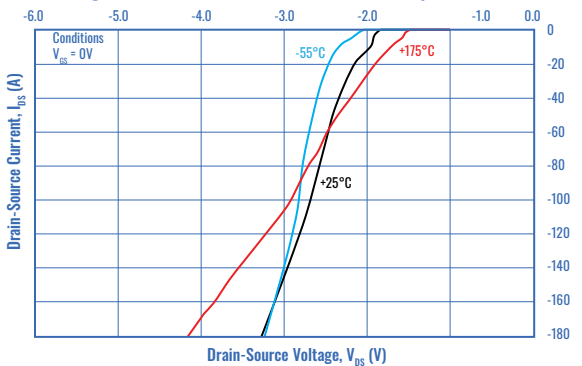
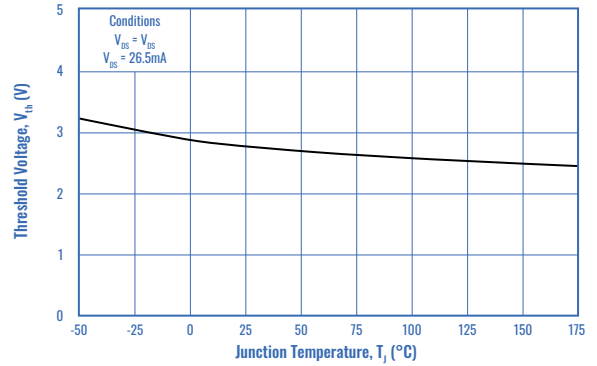
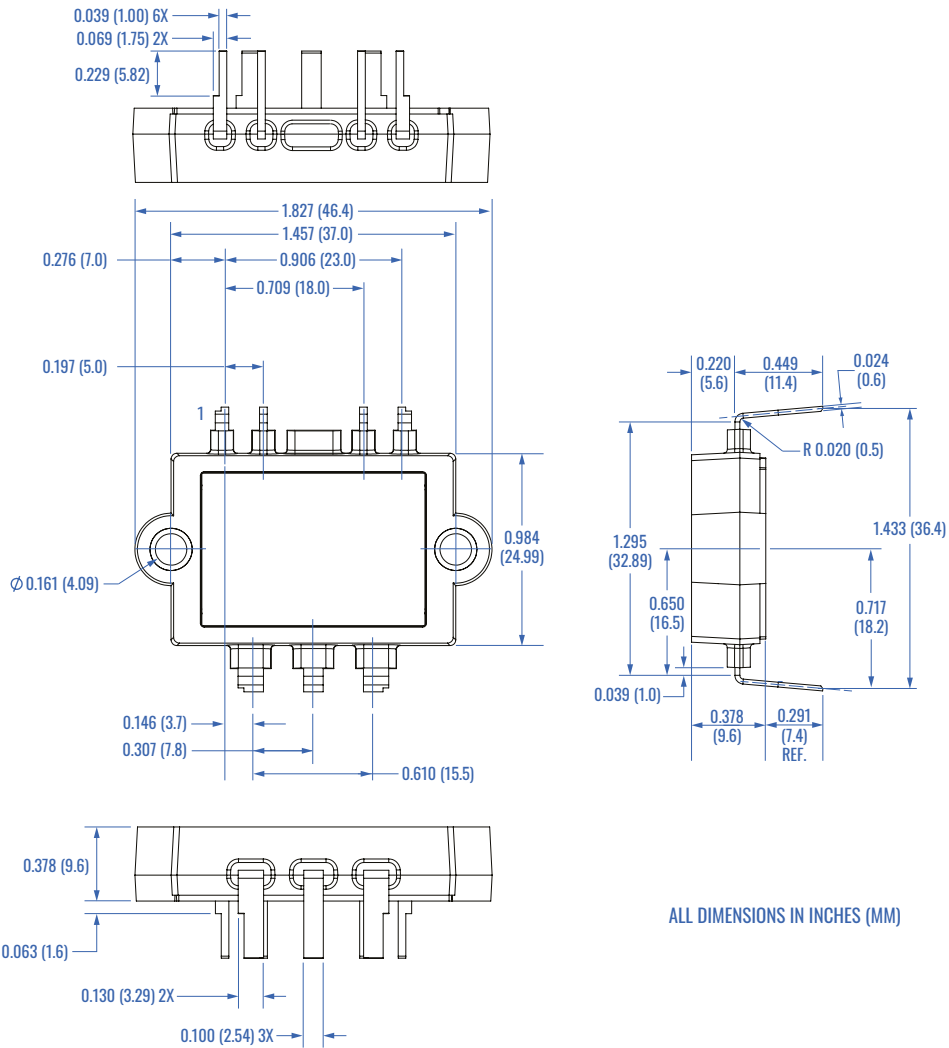

Fig 8: Threshold Voltage vs. Junction Temperature



PACKAGE OUTLINE - dimensions in inches (mm)



ALL DIMENSIONS IN INCHES (MM)

